

UNIKA 710

Kitchen Sinks

Code: N157 F50

UNIKA BOWL 71x40 À FLEUR



DETAILS

Edge/Installation Type	Flush-mount Top-mount
Finish	Foster brushed
Material	AISI 304 stainless steel
Texture	Foster brushed
Base	80 cm
Dimensions	750 x 440 mm
Standard fittings	Fixing hooks, gasket, drain, overflow and siphon, boxed packing
Mixer holes	No standard holes
Built-in hole	View technical data sheet

Drainer No

Width 75 cm

Bowl dimension 710 x 400 mm

Number of bowls 1 bowl

Waste fitting 3,5" drain

FEATURES

Basket 3,5" waste fitting The drain is equipped with a large 3.5" drain, with the practical basket cap that prevents the discharge of solid parts.

High thickness 1mm thick steel. A significant thickness, which guarantees the maximum sturdiness and durability.

Perimetral overflow The overflow is always a security on the Foster sinks that prevents the overflow of water in case of oversights. The perimeter drain solution improves aesthetics thanks to its square and essential shape.

Small radius Bowls with squared shapes with a modern design and an increased capacity, for a minimal aesthetics connected with an extreme practicality.

TECHNICAL DATA



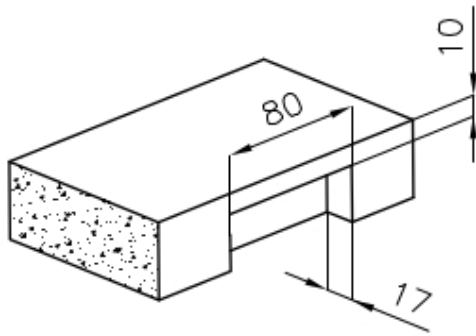

Intaglio per il troppo-pieno
Recess for housing the over-flow



- Built-in cut out for FTS – Foratura per installazione FTS

OPTIONAL ACCESSORIES



CUVETTE PERFOREE INOX

A154 F00

* only in combination with the accessory
A644 F04



CUVETTE PLASTIQUE BLANCHE

A153 A00



**GRILLE POR.ASSIETTES INOX
mm214x379**

A100 C03

* only in combination with the accessory
A644 A01

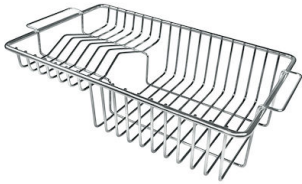

GRILLE PORTE-ASSIETTES INOX

250x425

A100 B01



GRILLE PORTE-ASSIETTES INOX

25x35

A100 A54

* only in combination with the accessory
A644 F04



PLANCHE DE DECOUPE CRYSTAL

23x41 CM

A631 C00



**PLANCHE DE DECOUPE DOUBLE
HDPE**

A644 A01



**PLANCHE DE DECOUPE DOUBLE
IROKO**

A644 F04



PLANCHE DE DECOUPE HDPE

27x42 CM

A657 F01



CUVETTE INOX PERFOREE

A151 F00

* only in combination with the accessory
A644 A01



**KIT RÂPES ET PLANCHE DE
DECOUPE HDPE**

A159 A01

* only in combination with the accessory
A644 A01

OPTIONAL AUTOMATIC WASTE FITTINGS



VIDAGE FADE LIGHT
A407 A17



VIDAGE FADE PUSH INOX
A407 A16